



HPS III-MHR122 radial version

Technical data

Version 12/2023

HPS III-MHR122 radial version

for use as system nozzle directly under the manifold

Dimensions and tip versions

Number of tips	1, 2
Version	System nozzle for standard installation
Nozzle length (Dim. G) ⁽¹⁾	90

Tip versions	90°	60°
Pitch diameter (Dim. Y)	50	50
Dim. X	60	63
Recommended gate diameters	0.5 - 1.2	0.9 - 1.5

(1) Other nozzle lengths available on request

Item number:

System nozzle: **MHR122-95...**

Each nozzle will be configured individually to suit your application requirements. Please contact us!

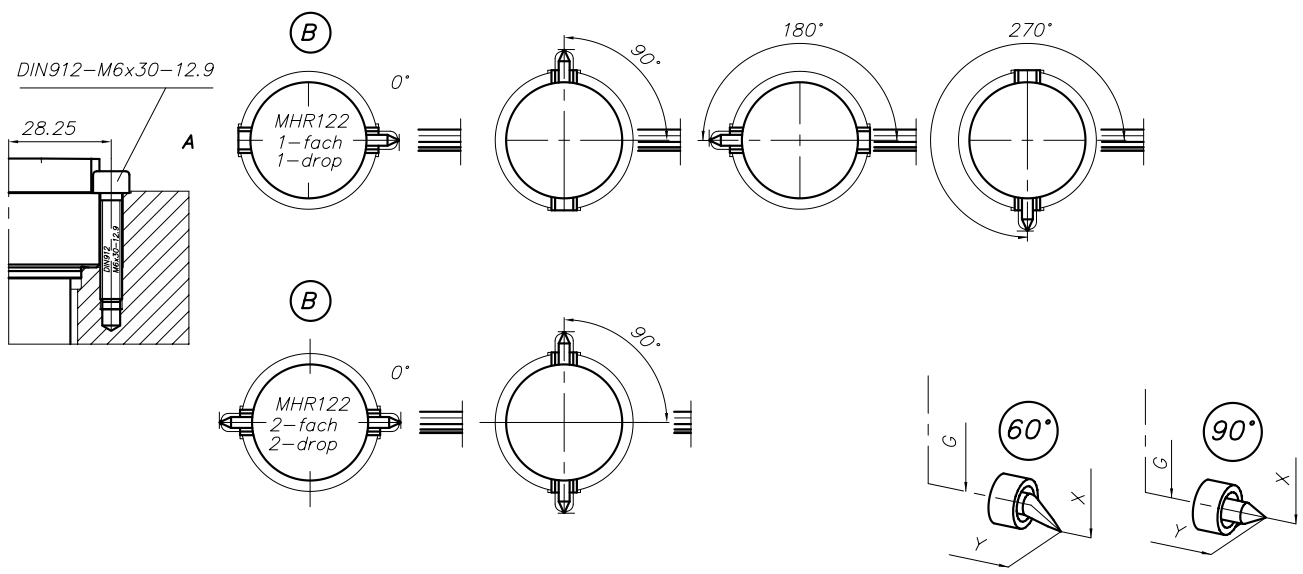
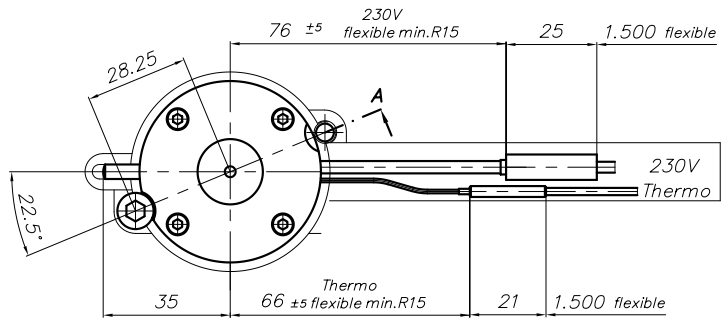
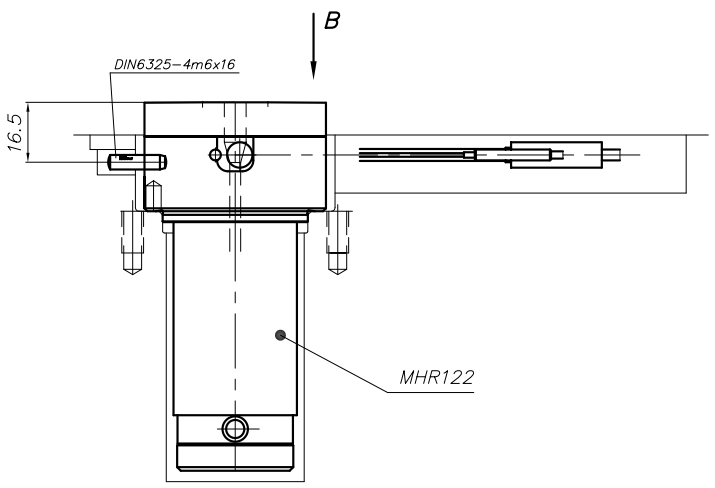
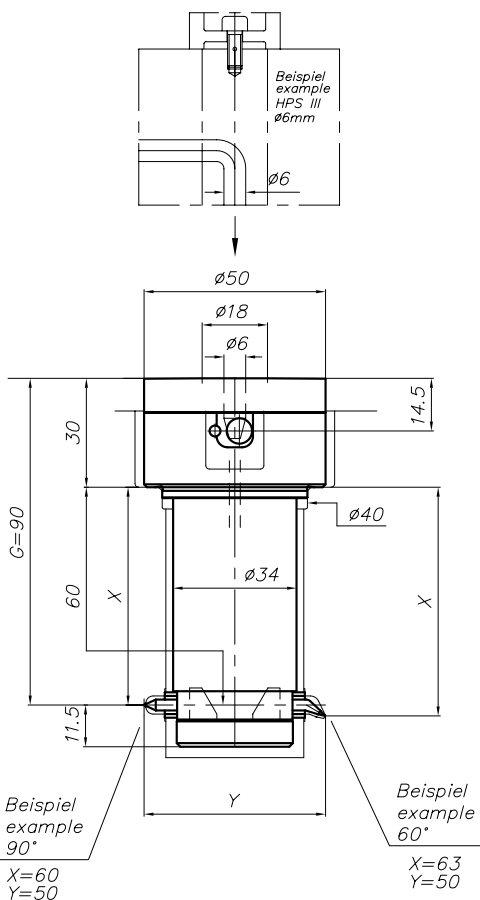

HPS III-MHR122 radial version

Installation

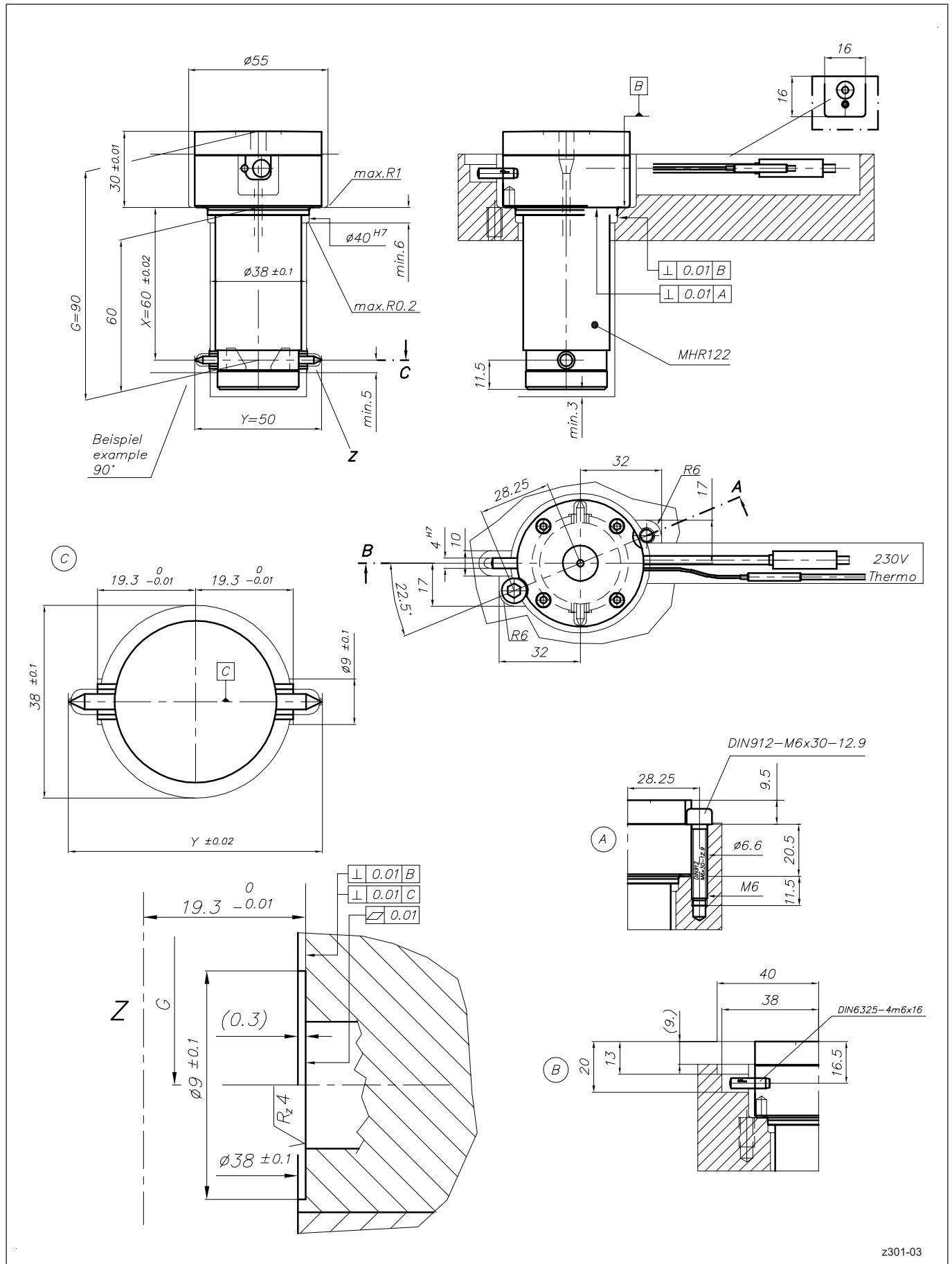

HPS III-MHR122 radial version

Details of gating geometries

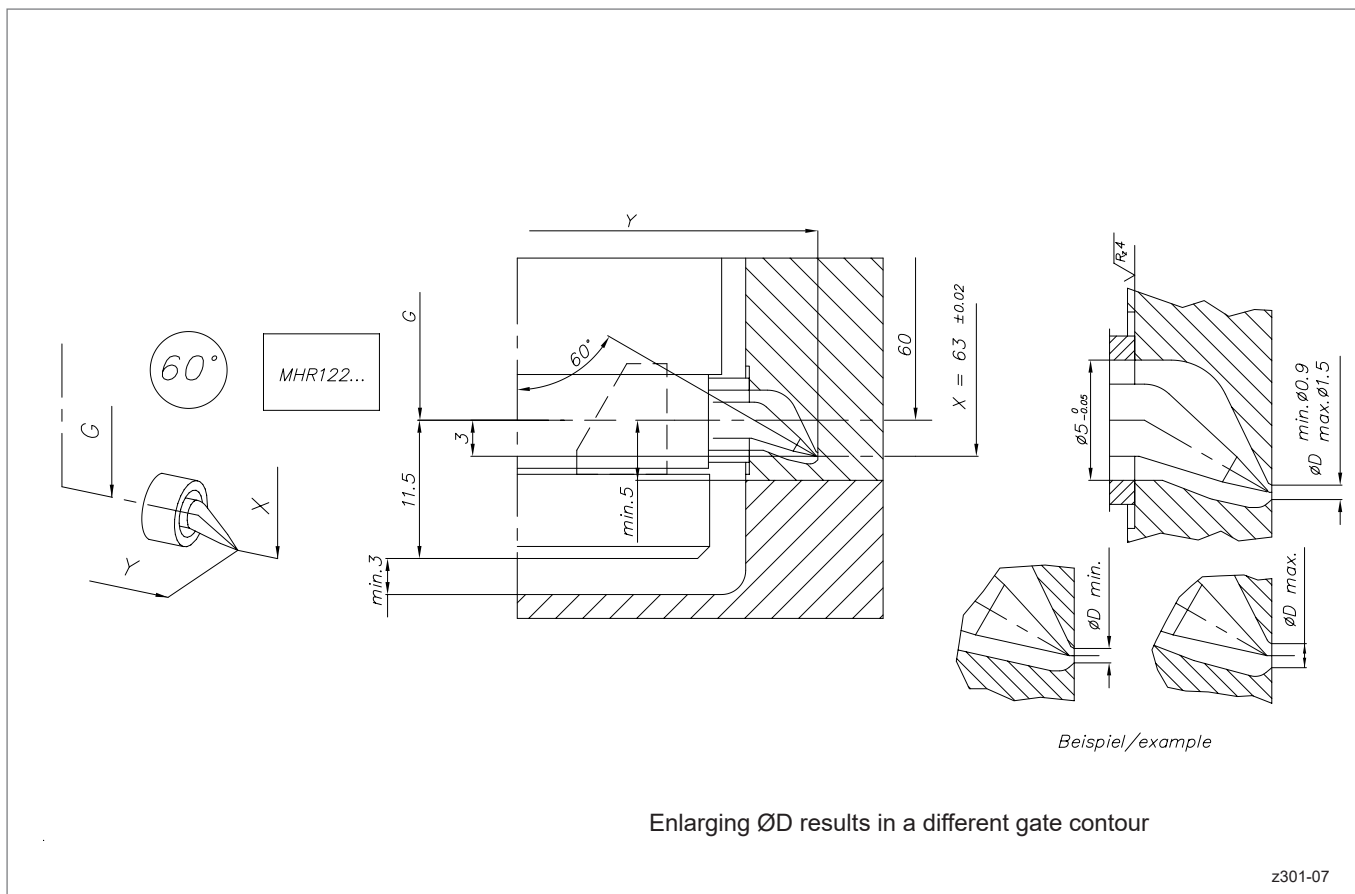
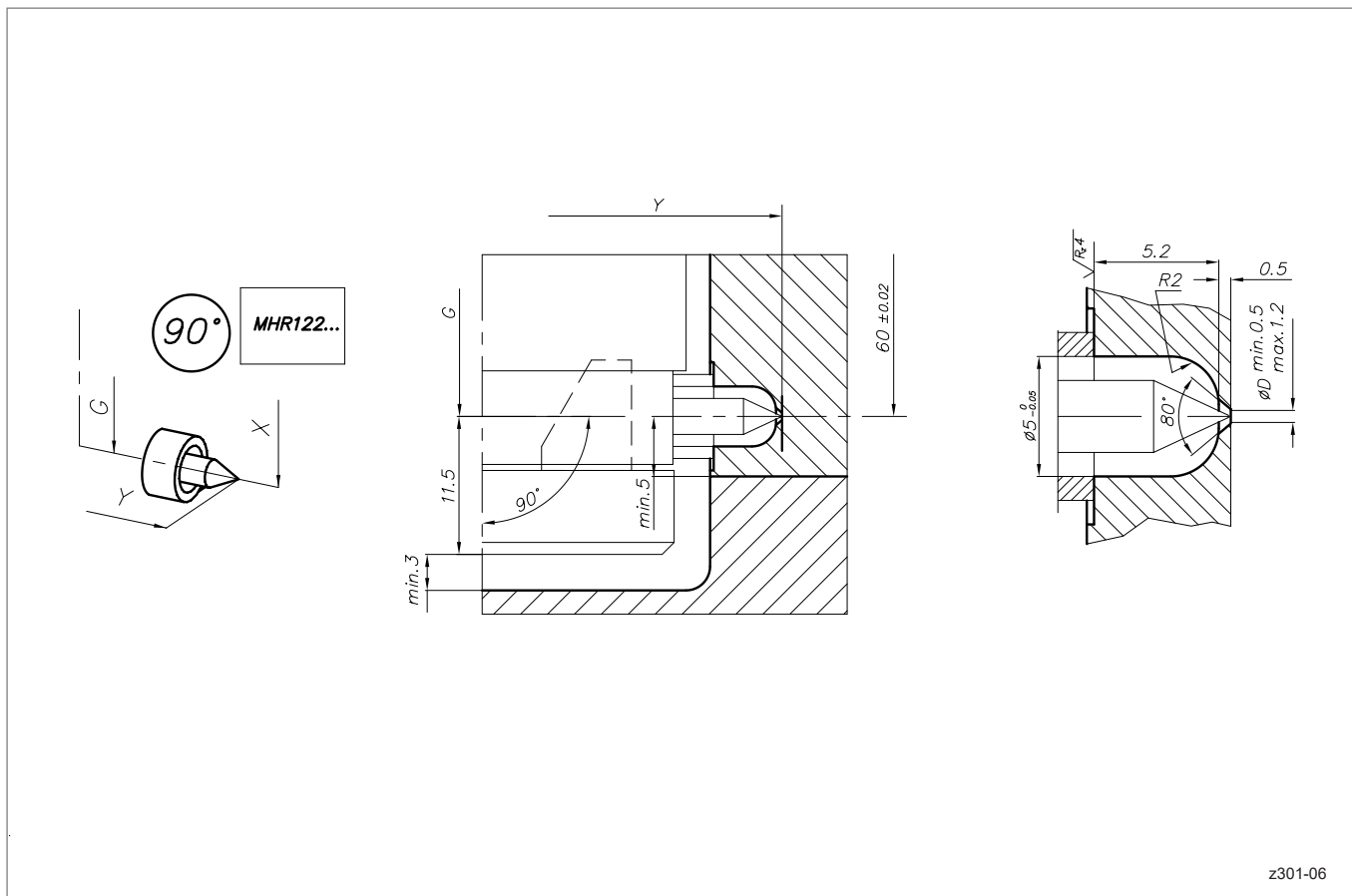

HPS III-MHR122 radial version

Assembly example

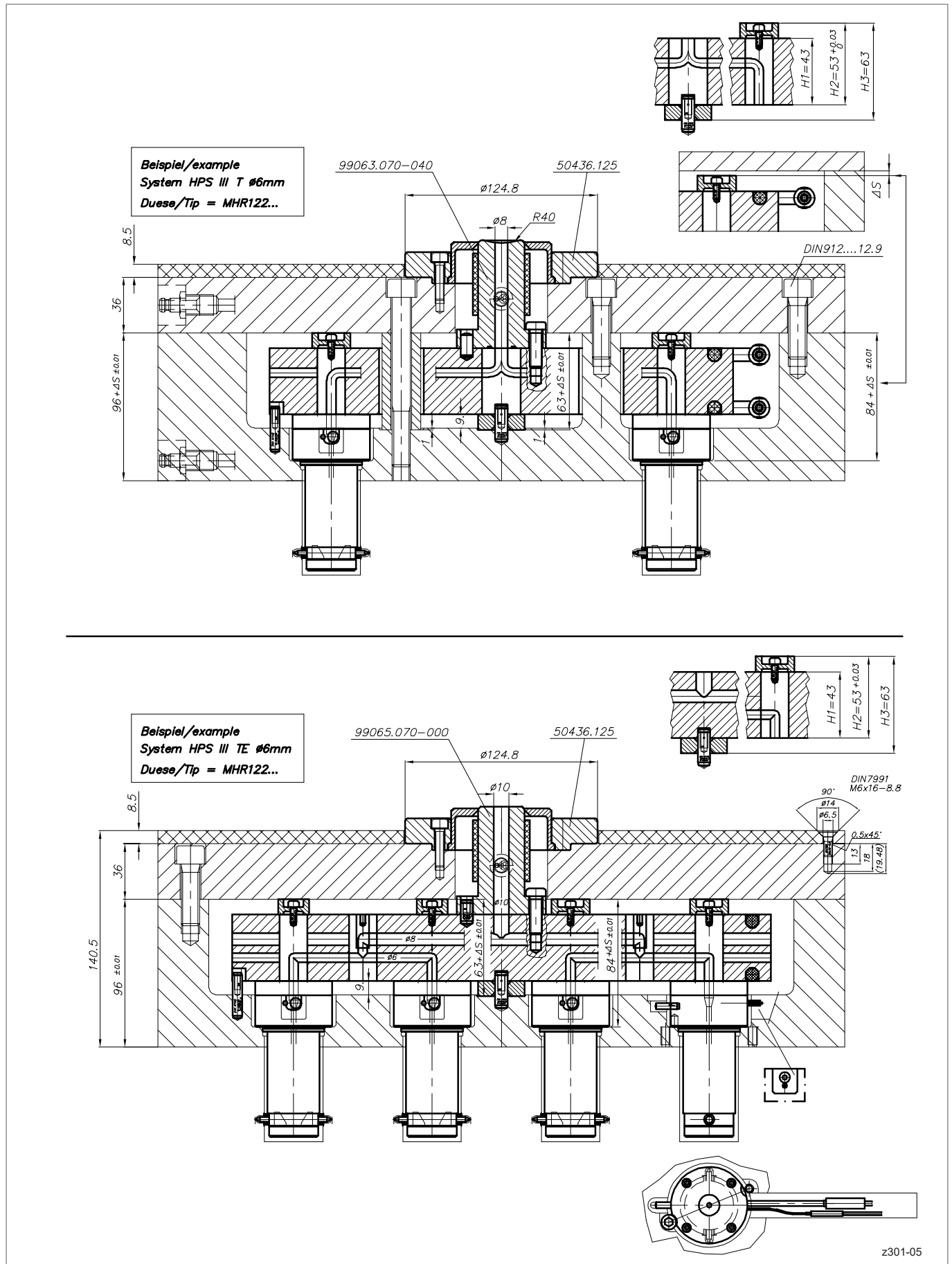

EWIKON Heißkanalsysteme GmbH
Siegener Straße 35 • 35066 Frankenberg / Germany
Tel: +49 6451 501-0 • E-Mail: info@ewikon.com
www.ewikon.com

Technical information subject to alteration | EWIKON 12/2023 EN

